

ELECTRICAL BOARD CONNECTIONS ACCESS

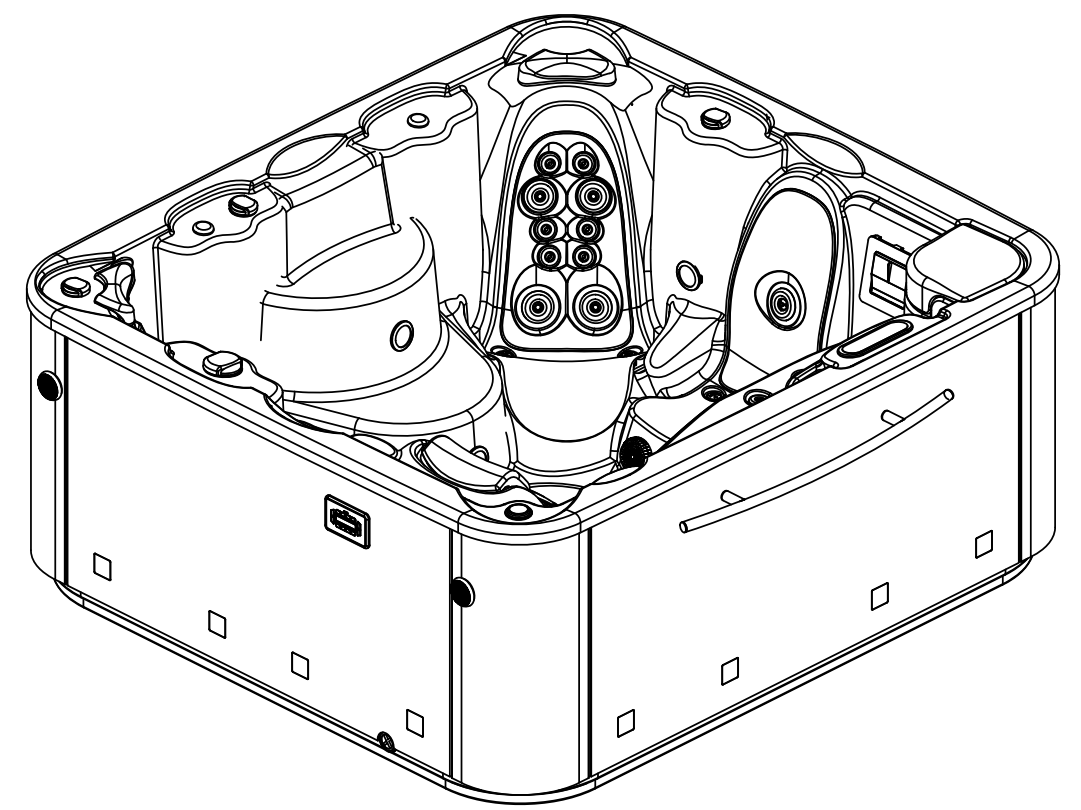

VALID FROM 09/06/2016

Inground option

WARNING:
It's essential to keep a minimum clearance access of **700mm** all around.

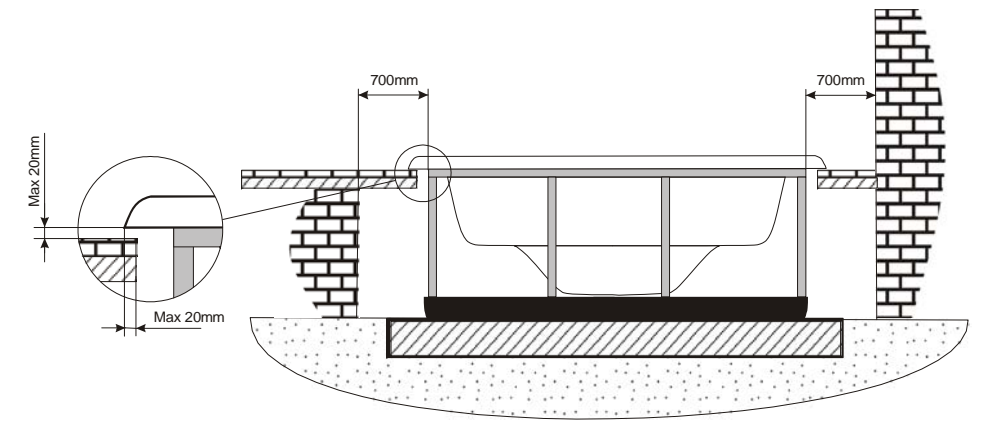

According to our policy of continuous improvement, dimensions, features or components of this product can be partially or completely changed without prior notice.
It's Customer responsibility to verify that this is the last version of the drawing

Change No.	Date	Name	Modification
05	28/06/2016	I.Pozo	New templates
04	26/11/2014	I.Pozo	Add light components and pure line
03	22/10/2014	I.Pozo	Change scale and new spare template
02	02/06/2014	I.Pozo	New templates

Remarks Dimensions in mm. General Tolerances +/- 10mm			COMMERCIAL		
Drawn	25/09/2012	X.Codina		Part Number	Rev.
Checked	25/09/2012	I.Nicolas		52565	05
Scale	1:15	General Tolerance			First Angle Projection
Sheet	1/3	DIN 7168 ISO 2768g			

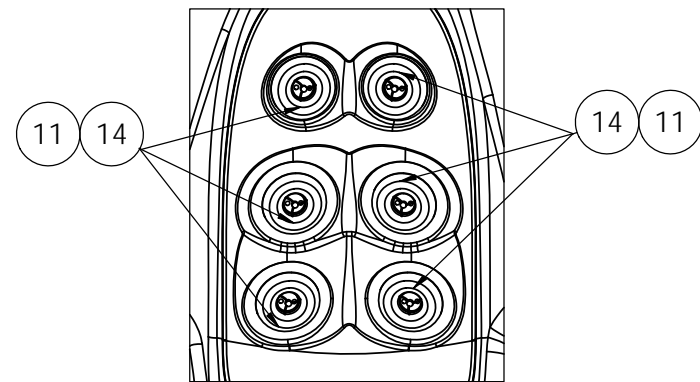
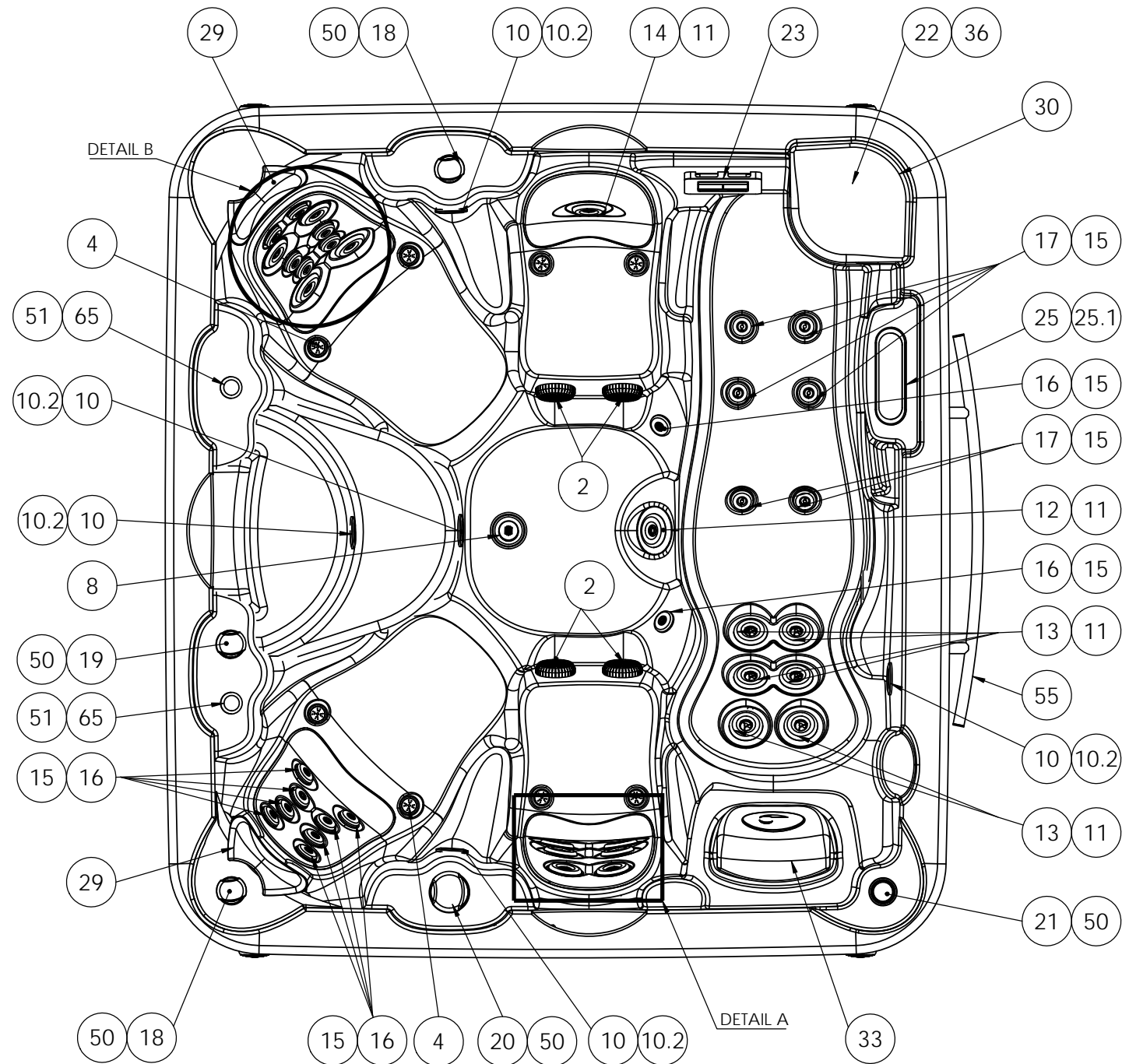

A (1 : 10)

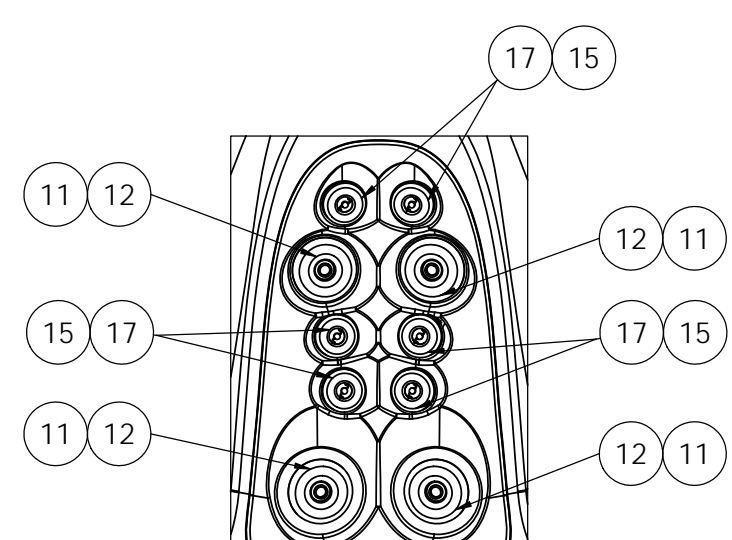

B (1 : 10)

ACCESSORIES			
Position Num.	PartNo SPARE	Description SPARE	Quant.
2	RPOR0225	GREY SPA DRAIN 2" ADAPTOR SOCKET D.50	4
4	REMP0046	WHITE-STAINLESS STEEL AIR NOZZLE	8
8	RPOR0003	GREY DRAIN SET - BODY+COVER+ASSEMBLY	1
10	RPOR0239	SPOTLIGHT LED SET RD	5
10.2	RPOR0252	LED SLAVE LIGHT	5
11	RPOR0236	JET BODY SET RD 3"	18
12	RPOR0231	FRONTAL JET 3" STAINLESS STEEL DIRECTIONAL	5
13	RPOR0232	FRONTAL JET 3" STAINLESS STEEL 1 JET ROTO	6
14	RPOR0233	FRONTAL JET 3" STAINLESS STEEL TWIN ROTO	7
15	RPOR0235	JET BODY SET RD 2"	24
16	RPOR0230	FRONTAL JET 2" STAINLESS STEEL DIRECTIONAL	12
17	RPOR0260	JET TWIN ROTO 2" INOX	12
18	RPOR0261	VENTURY CONTROLLER SS	2
19	RPOR0263	VALVE ON-OFF 1" SS	1
20	RPOR0262	3 WAYS SS VALVE 2"	1
21	RPOR0264	AROMA DISPENSER ASM LIT	1
22	RPOR0119	PRESSURE FILTER 2"	1
23	RPOR0178	SKIMMER FILTER GRIS for preassure filter	1
25	RPOR0196	DIGITAL PANEL VL700+COVER 2 PUMP + BLOWER	1
25.1	RPOR0202	COVER DIGITAL PANEL VL700 2 PUMP + BLOWER	1
29	RPOR0095	SMALL HEADREST - PACIFIC-ANTARTIC	2
30	RPOR0156	SKIMFILTER COVER	1
33	RPOR0094	BIG HEADREST - PACIFIC-ANTARTIC-EVOLUTION	1
36	RPOR0120	PRESSURE FILTER CARTRIDGE	1
49	RPOR0136	DRAIN FILL VALVE (BLACK)	1
50	RPOR0267	4 LEDS LIGHTS POINTS	5
51	RPOR0268	1 LED LIGHT POINT	2
55	RPOR0198	SPECIAL HANDGRIP SPA 1000	1
65	RPOR0284	FOUTAIN POP-UP	2
70	RPOR0280	LEDS TRANSFORMER 5V DC	1
71	RPOR0281	LEDS CONTROLER	1
73	RPOR0259	CABLE 4 OUTPUTS + LEDS	4
100	RPOR0314	AQUATIC GRILL BLACK SPEAKER 2"	4
101	RPOR0320	MINISPEAKER BLACK 2"	4
102	RPOR0326	INFINITY BLUETOOTH SYSTEM	1

VALID FROM 09/06/2016

According to our policy of continuous improvement, dimensions, features or components of this product can be partially or completely changed without prior notice. It's Customer responsibility to verify that this is the last version of the drawing

Change No.	Date	Name	Modification
05	28/06/2016	I.Pozo	New templates
04	26/11/2014	I.Pozo	Add light components and pure line
03	22/10/2014	I.Pozo	Change scale and new spare template
02	02/06/2014	I.Pozo	New templates

Remarks Dimensions in mm. General Tolerances +/- 10mm			SPARE PARTS DRAWING		
Drawn	25/09/2012	X.Codina			
Checked	25/09/2012	I.Nicolas	Rev.	05	First Angle Projection
Scale	1:15	General Tolerance			
Sheet	2/3	DIN 7168 ISO 2768g			

Property of IBERSPA S.L. Avda. Pla d'Urgell 2-8 25200 Cervera, Spain. Don't use without permission. Keep this information confidential and use it solely for the permitted purpose.

PUMPS SPARE CODES

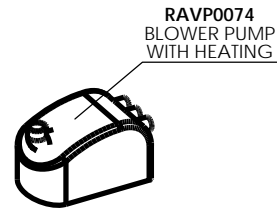
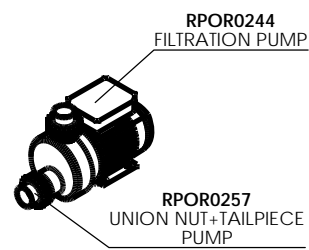
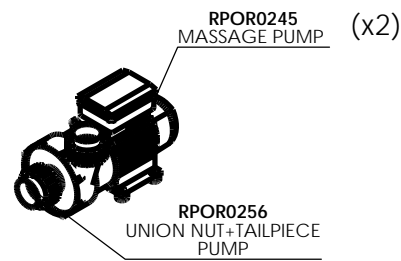

HEATER AND DESINFECTION SPARE CODES

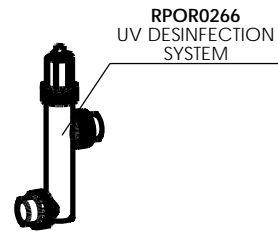
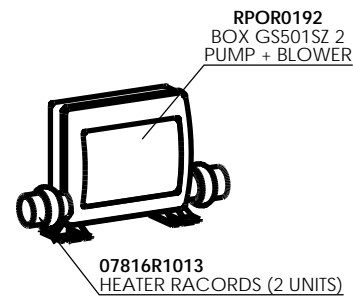

RPOR0101 - TEMPERATURE PROBES GS I GL (x 2)
RPOR0105 - HEATER 3 KW GS I GL
RPOR0197 - DIGITAL PANEL GS501SZ
RPOR0193 - EXPANDER BOARD KIT FOR SISTEM GS501SZ

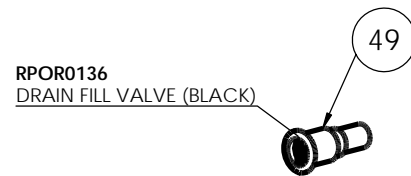

AUDIO SPARE CODES

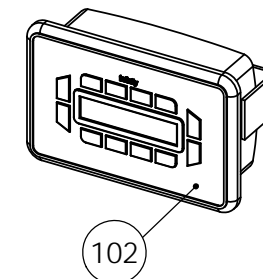
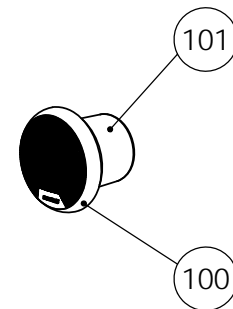
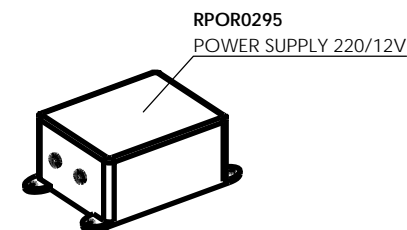
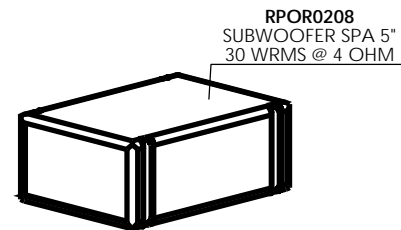

LIGHT COMPONENTS SPARE CODES

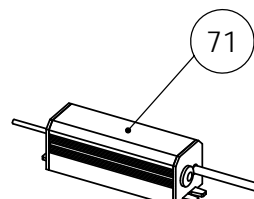
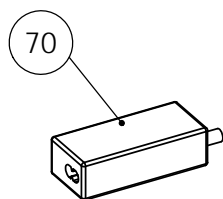

PURE LINE LIGHTING SPARE CODES

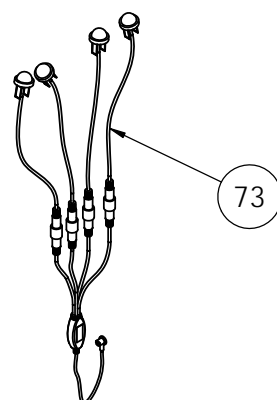

ACCESSORIES			
Position Num.	PartNo SPARE	Description SPARE	Quant.
2	RPOR0225	GREY SPA DRAIN 2" ADAPTOR SOCKET D.50	4
4	REMP0046	WHITE-STAINLESS STEEL AIR NOZZLE	8
8	RPOR0003	GREY DRAIN SET - BODY+COVER+ASSEMBLY	1
10	RPOR0239	SPOTLIGHT LED SET RD	5
10.2	RPOR0252	LED SLAVE LIGHT	5
11	RPOR0236	JET BODY SET RD 3"	18
12	RPOR0231	FRONTAL JET 3" STAINLESS STEEL DIRECTIONAL	5
13	RPOR0232	FRONTAL JET 3" STAINLESS STEEL 1 JET ROTO	6
14	RPOR0233	FRONTAL JET 3" STAINLESS STEEL TWIN ROTO	7
15	RPOR0235	JET BODY SET RD 2"	24
16	RPOR0230	FRONTAL JET 2" STAINLESS STEEL DIRECTIONAL	12
17	RPOR0260	JET TWIN ROTO 2" INOX	12
18	RPOR0261	VENTURY CONTROLLER SS	2
19	RPOR0263	VALVE ON-OFF 1" SS	1
20	RPOR0262	3 WAYS SS VALVE 2"	1
21	RPOR0264	AROMA DISPENSER ASM LIT	1
22	RPOR0119	PRESSURE FILTER 2"	1
23	RPOR0178	SKIMMER FILTER GRIS for preasure filter	1
25	RPOR0196	DIGITAL PANEL VL700+COVER 2 PUMP + BLOWER	1
25.1	RPOR0202	COVER DIGITAL PANEL VL700 2 PUMP + BLOWER	1
29	RPOR0095	SMALL HEADREST - PACIFIC-ANTARTIC	2
30	RPOR0156	SKIMFILTER COVER	1
33	RPOR0094	BIG HEADREST - PACIFIC-ANTARTIC-EVOLUTION	1
36	RPOR0120	PRESSURE FILTER CARTRIDGE	1
49	RPOR0136	DRAIN FILL VALVE (BLACK)	1
50	RPOR0267	4 LEDS LIGHTS POINTS	5
51	RPOR0268	1 LED LIGHT POINT	2
55	RPOR0198	SPECIAL HANDGRIP SPA 1000	1
65	RPOR0284	FOUTAIN POP-UP	2
70	RPOR0280	LEDS TRANSFORMER 5V DC	1
71	RPOR0281	LEDS CONTROLER	1
73	RPOR0259	CABLE 4 OUTPUTS + LEDS	4
100	RPOR0314	AQUATIC GRILL BLACK SPEAKER 2"	4
101	RPOR0320	MINISPEAKER BLACK 2"	4
102	RPOR0326	INFINITY BLUETOOTH SYSTEM	1

VALID FROM 09/06/2016

According to our policy of continuous improvement, dimensions, features or components of this product can be partially or completely changed without prior notice. It's Customer responsibility to verify that this is the last version of the drawing

Change No.	Date	Name	Modification
05	28/06/2016	I.Pozo	New templates
04	26/11/2014	I.Pozo	Add light components and pure line
03	22/10/2014	I.Pozo	Change scale and new spare template
02	02/06/2014	I.Pozo	New templates

Remarks Dimensions in mm. General Tolerances +/- 10mm			SPARE PARTS DRAWING		
Drawn	25/09/2012	X.Codina			
Checked	25/09/2012	I.Nicolas	Rev.	05	
Scale	1:5	General Tolerance			
Sheet	3/3	DIN 7168 ISO 2768g			

Property of IBERSPA S.L. Avda. Pla d'Urgell 2-8 25200 Cervera, Spain. Don't use without permission. Keep this information confidential and use it solely for the permitted purpose.